

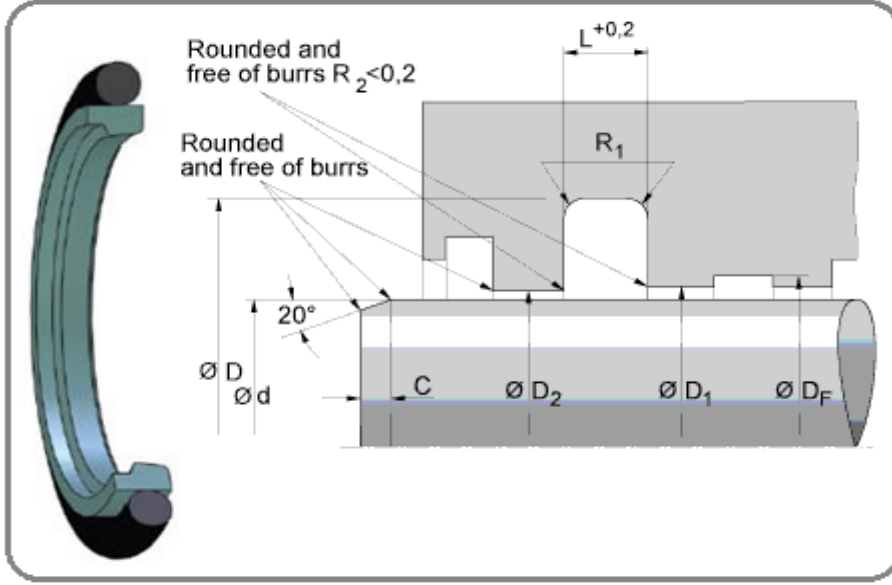



HİDROLİK - BOĞAZ SIZDIRMAZLIK ELEMANI - BOĞAZ KEÇESİ - W035

W035 boğaz keçeleri , özel ürün PTFE ve kauçuk oringden oluşmaktadır. Bu ürün hareketli ve hareketsiz ortamlarda mükemmel çalışır. Ağırlıklı olarak enjeksiyon makinalarında , iş makinalarında , otomotiv sektöründe kullanılmaktadır. Yüksek sıcaklıklarda ise viton oring ile beraber özel üretim PTFE kullanılmaktadır.



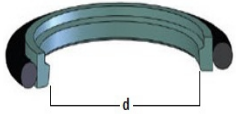
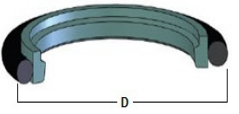

Logo	Ø d	Ø D	Ø D ₁	Ø D _F
W035-008	8	12,9	2,2	9,66x1,78
W035-010	10	14,9	2,2	11,11x1,78
W035-012	12	19,3	3,2	13,95x2,62
W035-014	14	21,3	3,2	17,13x2,62
W035-015	15	19,9	2,2	17,17x1,78
W035-016	16	23,3	3,2	18,72x2,62
W035-018	18	25,3	3,2	20,29x2,62
W035-018/1	18	22,9	2,2	18,77x1,78
W035-020	20	30,7	4,2	24,99x3,53
W035-020/1	20	27,3	3,2	22,22x2,62
W035-022	22	32,7	4,2	26,58x3,53
W035-022/1	22	29,5	3,2	25,07x2,62
W035-025	25	35,7	4,2	31,34x3,53
W035-025,40	25,4	36,1	4,2	29,75x3,53
W035-025/1	25	32,3	3,2	28,25x2,62
W035-026	26	36,7	4,2	31,34x3,53
W035-028	28	38,7	4,2	32,92x3,53
W035-028/1	28	35,3	4,2	29,82x2,62
W035-030	30	40,7	4,2	34,52x3,53
W035-030/1	30	37,3	3,2	33,00x2,62
W035-032	32	42,7	4,2	36,09x3,53
W035-032/1	32	39,3	3,2	34,59x2,62
W035-035	35	45,7	4,2	37,69x3,53
W035-035/1	35	42,3	3,2	37,77x2,62

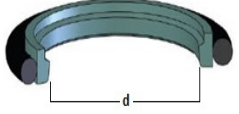
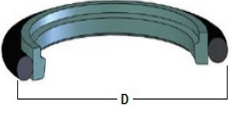

HİDROLİK - BOĞAZ SIZDIRMAZLIK ELEMANI - BOĞAZ KEÇESİ - W035

				
W035-036	36	46,7	4,2	40,87x3,53
W035-036/1	36	43,3	3,2	39,34x2,62
W035-038	38	48,7	4,2	40,87x3,53
W035-040	40	55,1	6,3	43,82x5,33
W035-040/1	40	50,7	4,2	44,45x3,53
W035-042	42	52,7	4,2	47,22x3,53
W035-045	45	60,1	6,3	50,16x5,33
W035-045/1	45	55,7	4,2	50,39x3,53
W035-048	48	63,1	6,3	53,34x5,33
W035-048/1	48	58,7	4,2	50,80x3,53
W035-050	50	65,1	6,3	56,52x5,33
W035-050,8	50,8	61,5	4,2	53,57x3,53
W035-050/1	50	60,7	4,2	53,57x3,53
W035-052	52	62,7	4,2	56,74x3,53
W035-052/1	52	67,1	6,3	56,52x5,33
W035-055	55	70,1	6,3	59,69x5,33
W035-056	56	71,1	6,3	62,87x5,33
W035-056/1	56	66,7	4,2	59,92x3,53
W035-060	60	75,1	6,3	66,04x5,33
W035-060/1	60	70,7	4,2	63,09x3,53
W035-063	63	78,1	6,3	69,22x5,33
W035-063,5	63,5	78,6	6,3	69,22x5,33
W035-063/1	63	73,7	4,2	66,04x3,53
W035-065	65	80,1	6,3	69,22x5,33
W035-065/1	65	75,7	4,2	68,26x3,53
W035-067	67	82,1	6,3	72,40x5,33
W035-068	68	83,1	6,3	72,40x5,33
W035-068/1	68	78,7	4,2	72,62x3,53
W035-070	70	85,1	6,3	72,62x3,53
W035-070/1	70	80,7	4,2	75,79x3,53
W035-073	73	88,1	6,3	75,79x3,53
W035-075	75	90,1	6,3	81,92x5,33
W035-080	80	95,1	6,3	85,09x5,33
W035-080/1	80	90,7	4,2	85,32x3,53
W035-085	85	100,1	6,3	91,44 x 5,33
W035-090	90	105,1	6,3	94,62 x 5,33
W035-092	92	107,1	6,3	97,80x5,33
W035-095	95	110,1	6,3	100,97 x 5,33
W035-095/1	95	115,1	8,1	104,14x6,99
W035-100	100	115,1	6,3	107,32 x 5,33
W035-100/1	100	110,7	4,2	104,37x3,5,33
W035-105	105	125,5	8,1	113,67x6,99
W035-105/1	105	120,1	6,3	110,49x5,33
W035-110	110	125,1	6,3	116,84 x 5,33
W035-110/1	110	130,5	8,1	116,84x6,99
W035-110/2	110	120,7	4,2	116,84x6,99
W035-115	115	130,1	6,3	120,02 x 5,33
W035-120	120	135,1	6,3	126,57 x 5,33

HİDROLİK - BOĞAZ SIZDIRMAZLIK ELEMANI - BOĞAZ KEÇESİ - W035

				
W035-125	125	140,1	6,3	130,18 x 5,33
W035-125/1	125	145,5	8,1	132,72x6,99
W035-130	130	145,1	6,3	135,89 x 5,33
W035-130/1	130	150,5	8,1	139,07x6,99
W035-132	132	147,1	6,3	139,07x5,33
W035-135	135	150,1	6,3	137,70 x 5,33
W035-137	137	152,1	6,3	142,24x5,33
W035-138	138	153,1	6,3	142,24x5,33
W035-140	140	155,1	6,3	145,42 x 5,33
W035-145	145	160,1	6,3	151,77x5,33
W035-145/1	145	165,5	8,1	151,77x5,33
W035-150	150	165,1	6,3	151,77 x 5,33
W035-150/1	150	170,5	8,1	158,12x6,99
W035-153	153	168,1	6,3	158,12x5,33
W035-155	155	170,1	6,3	161,30x5,33
W035-160	160	175,1	6,3	164,47 x 5,33
W035-160/1	160	180,5	8,1	164,47x6,99
W035-165	165	180,1	6,3	170,82x5,33
W035-170	170	185,1	6,3	177,17x5,33
W035-170/1	170	190,5	8,1	177,17x6,99
W035-172/1	172	192,5	8,1	183,52x6,99
W035-175	175	190,1	6,3	177,17x5,33
W035-180	180	195,1	6,3	183,52x5,33
W035-180/1	180	200,5	8,1	187,30x6,99
W035-185	185	200,1	6,3	189,87x5,33
W035-190	190	205,1	6,3	196,22x5,33
W035-192	192	207,1	6,3	196,22x5,33
W035-195	195	210,1	6,3	202,57x5,33
W035-200	200	220,5	8,1	208,92x6,99
W035-210	210	230,5	8,1	215,27x6,99
W035-212	212	232,5	8,1	215,27x6,99
W035-215	215	235,5	8,1	227,97x6,99
W035-220	220	240,5	8,1	227,97x6,99
W035-225	225	245,5	8,1	240,67x6,99
W035-230	230	250,5	8,1	240,67x6,99
W035-235	235	255,5	8,1	240,67x6,99
W035-240	240	260,5	8,1	240,67x6,99
W035-245	245	265,5	8,1	253,57x6,99
W035-250	250	270,5	8,1	253,57x6,99
W035-260	260	284	8,1	266,07x6,99
W035-260/1	260	280,5	8,1	266,07x6,99
W035-270	270	294	8,1	278,77x6,99
W035-275	275	299	8,1	291,47x6,99
W035-280	280	304	8,1	291,47x6,99
W035-285	285	309	8,1	291,47x6,99
W035-290	290	314	8,1	297,88x6,99
W035-295	295	319	8,1	304,17x6,99
W035-300	300	324	8,1	316,87x6,99

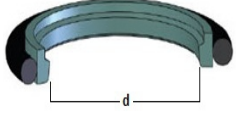
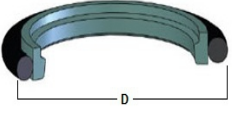
HİDROLİK - BOĞAZ SIZDIRMAZLIK ELEMANI - BOĞAZ KEÇESİ - W035

				
W035-300/1	300	320,5	8,1	304,17x6,99
W035-310	310	334	8,1	316,87x6,99
W035-320	320	344	8,1	329,57x6,99
W035-330	330	354	8,1	342,27x6,99
W035-340	340	364	8,1	354,97x6,99
W035-345	345	369	8,1	354,97x6,99
W035-350	350	374	8,1	354,9x6,99
W035-360	360	384	8,1	367,67x6,99
W035-370	370	394	8,1	380,37x6,99
W035-380	380	404	8,1	393,07x6,99
W035-390	390	414	8,1	405,26x6,99
W035-400	400	424	8,1	417,96x6,99
W035-405	405	429	8,1	417,96x6,99
W035-420	420	444	8,1	430,66x6,99
W035-430	430	454	8,1	443,36x6,99
W035-450	450	474	8,1	468,76x6,99
W035-460	460	484	8,1	468,76x6,99
W035-470	470	494	8,1	481,46x6,99
W035-480	480	504	8,1	494,16x6,99
W035-490	490	514	8,1	506,86x6,99
W035-500	500	524	8,1	506,86x6,99
W035-510	510	534	8,1	532,26x6,99
W035-520	520	544	8,1	532,26x6,99
W035-530	530	554	8,1	557,66x6,99
W035-550	550	574	8,1	582,68x6,99
W035-570	570	594	8,1	582,68x6,99